



60*60*15 MM SERIES

***馬達 MOTOR:**

4極無刷馬達 4pole brushless DC motor

***框 FRAME:**

成型條件 Injection molded thermal plastic

PBT+30%GF UL 94V-0

***扇葉 IMPELLER:**

成型條件 Injection molded thermal plastic

PBT+15%GF UL 94V-0

***絕緣 INSULATION:**

10MΩ/between unshackled wire

and frame at 500 VDC/m

***操作溫度與濕度**

OPERATION TEMPERATURE&HUMIDITY:

-10°C~+60°C,35%~85%RH

***儲存溫度與濕度**

STORAGE TEMPERATURE&HUMIDITY:

-40°C~+70°C,35%~85%RH

***導線 WIRES:**

UL1007,28AWG,Red(+),Black(-)

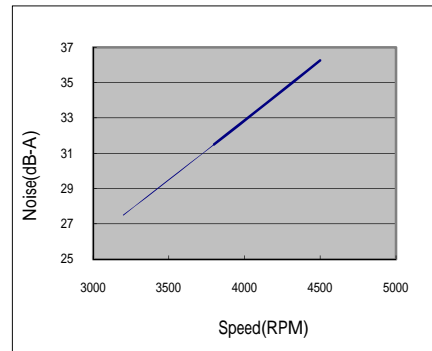

■ P&Q CURVE

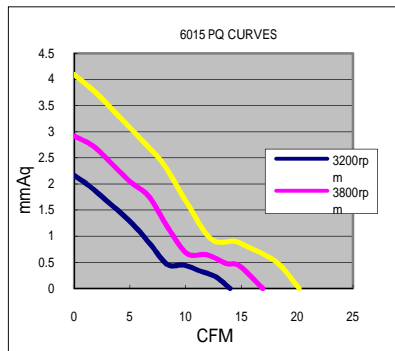

■ DIMENSIONS DRAWING

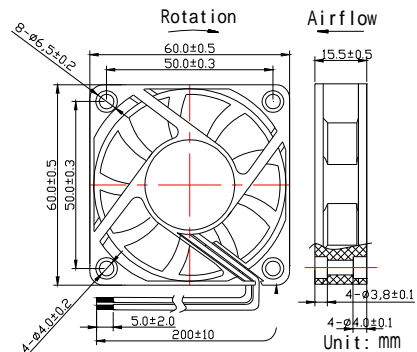

MODEL	Bearing	Rating Voltage	Rated Current	Rated Input Power	Operating Voltage range	Speed	Air Flow	Static Pressure	Noise
PART NO.		VDC	Amp	Watts	VDC	RPM	CFM	mm-H ₂ O	dB-A
A6015H12D	Two Ball	12	0.2	2.4	6 to 13	4500	20.16	4.10	36.3
A6015M12D			0.17	2.04	6to 13	3800	16.90	2.92	32.5
A6015L12D			0.14	1.68	6to 13	3200	13.97	2.16	29.0
A6015H12C	Ball& Sleeve		0.2	2.4	6 to 13	4500	20.16	4.10	36.3
A6015M12C			0.17	2.04	6to 13	3800	16.90	2.92	32.5
A6015L12C			0.14	1.68	6to 13	3200	13.97	2.16	29.0
A6015H12S	Sleeve		0.2	2.4	6 to 13	4500	20.16	4.10	36.3
A6015M12S			0.17	2.04	6to 13	3800	16.90	2.92	32.5
A6015L12S			0.14	1.68	6to 13	3200	13.97	2.16	29.0
A6015H24D	Two Ball	24	0.12	2.88	12 to 26	4500	20.16	4.10	36.3
A6015M24D			0.10	2.40	12 to 26	3800	16.90	2.92	32.5
A6015L24D			0.08	1.92	12 to 26	3200	13.97	2.16	29.0
A6015H24C	Ball& Sleeve		0.12	2.88	12 to 26	4500	20.16	4.10	36.3
A6015M24C			0.10	2.40	12 to 26	3800	16.90	2.92	32.5
A6015L24C			0.08	1.92	12 to 26	3200	13.97	2.16	29.0
A6015H24S	Sleeve		0.12	2.88	12 to 26	4500	20.16	4.10	36.3
A6015M24S			0.10	2.40	12 to 26	3800	16.90	2.92	32.5
A6015L24S			0.08	1.92	12 to 26	3200	13.97	2.16	29.0

USA Phone:+1-603-792-346 Fax:+1-603-792-3461
<http://www.vettecorp.com>

ASIA TAIWAN Phone:+886-2-7720-1188 Fax:+886-2-7720-1166
CHINA Phine:+86-769-83377088 Fax:+86-769-83710088
<http://www.vette.com.tw>